

The Allflex RS320 Stick Reader



User Manual

Allflex EID Readers with *Dynamic Tuning Network*TM

Congratulations for your acquisition of an Allflex EID reader.

This device is equipped with the new “DTN - *Dynamic Tuning Network*TM” technology, an exclusive Allflex innovation (patent pending).

The “DTN - *Dynamic Tuning Network*TM” technology provides a significant improvement of reader performance in several areas, including improved tag signal reception, better noise immunity and increased read distance.

This is obtained by dynamically optimizing the electrical characteristics of the reader antenna during tag activation and reception cycles.

Unpacking

The Allflex RS320 Stick Reader is offered for sale in several package types, depending on the country of purchase. Please refer to local websites / brochures to explain the specific package offered locally. As an example, Australia and New Zealand offer “Standard” and “Premium Kit” packages.

The standard RS320 kit is shipped in a cardboard shipping box and includes:

- RS320 Reader
- Instruction Guide
- 1 x 9.6 Volt DC NiMH rechargeable battery pack
- 100 / 240VAC – 12VDC Trickle Charger
- Power / Data Cable
- Allflex Stick Reader Configurator© CD-ROM or NLIS Link software CD-ROM (Australia only)
- 5-metre power supply with alligator clips *
- Snap hook

The “Premium Kit” is shown below and includes all of the items above except the 100 / 240VAC – 12VDC Trickle Charger, plus the following items.

- 2 extra 9.6 volt battery packs
- 1 extra serial cable
- AK320 Battery Pack Fast Charger and 100 / 240VAC-18VDC power supply
- Enclosed in a rugged plastic case



* Not proposed for sale in Europe.

Figure 1 - Stick Reader Features and User Interface



Stick Reader User Interface

Figure 1 illustrates the Stick Reader’s features that comprise the user interface and that are pertinent to its operation. Each feature and its corresponding functional description is described in Table 1 below.

Table 1 - Stick Reader Features and Descriptions of Use

Feature	Description of Use
Antenna ^[1]	Emits activation signal and receives transponder signal
Red LED Indicator	Illuminates whenever antenna is emitting activation signal (when green button is pressed)
Green LED Indicator	Illuminates whenever a transponder has been read
Audible Beeper ^[1]	Beeps once on first transponder reading and twice for repeat

^[1] Item is internal to enclosure and cannot be seen.

Green READ Button	Applies power and causes activation signal to be emitted for reading transponder
Data/Power Cable	Conveys external power to Reader and serial data to and from Reader
DB9 Connector w/ DC Power Jack	Connects serial data to PC, scale head, or data logger RS232 port. Accepts 12 VDC input as Reader power source
Fiberglass Tube	Rugged, watertight enclosure
Screw-on Endcap	Provides access to battery compartment
Handle Grip	Rubber anti-slip gripping surface
Cable Connector	Electrical interface for attaching Data/Power Cable

Preparing for use

In order to proceed, it is necessary first to fully charge the Battery Pack as described below and to have an few electronic identification eartags available for testing.



It is very important to carry out the following three steps before using the Stick Reader.

Step 1: Installing the battery pack in the Stick Reader

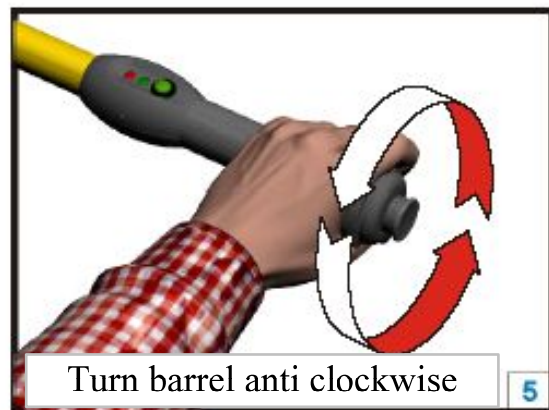
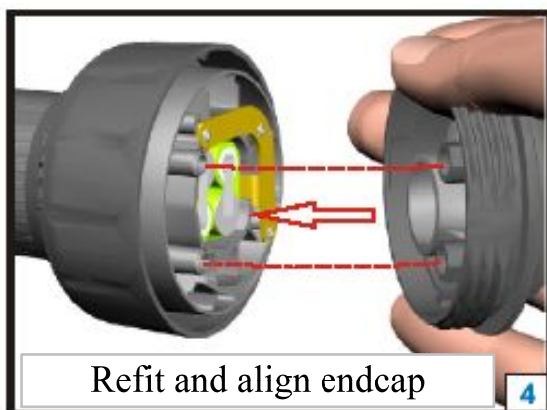
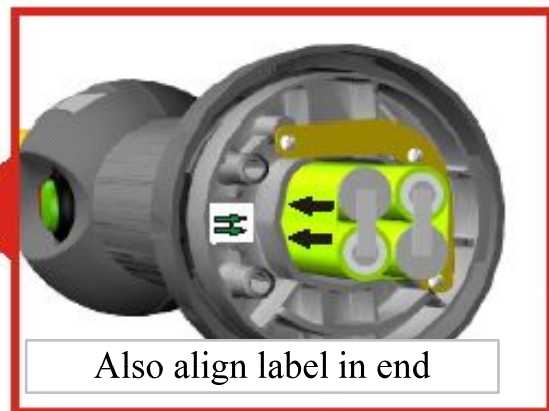
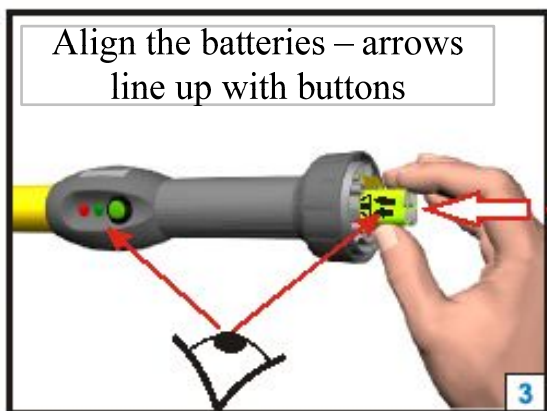
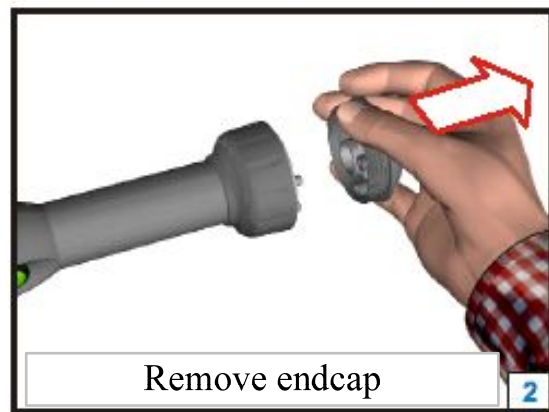
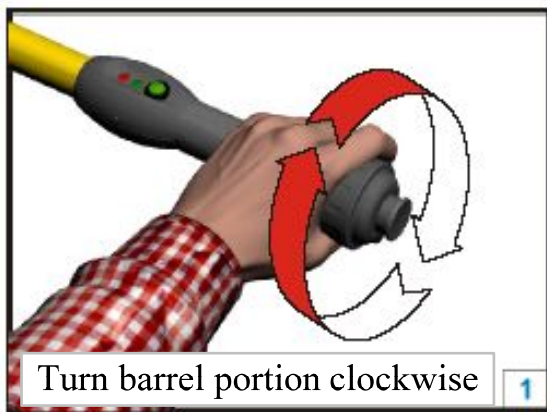

Step 2: Trickle charging the battery pack. (Applicable to the Standard Kit)

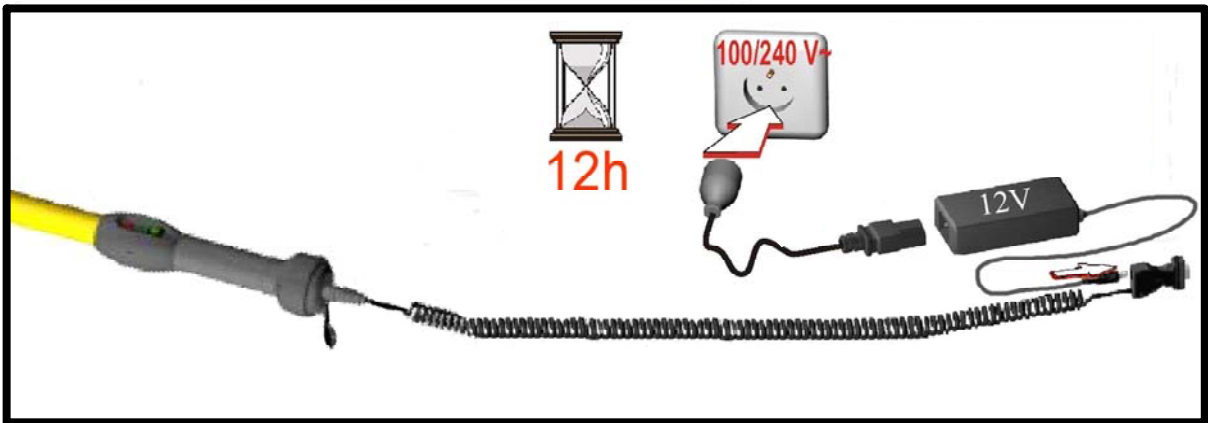
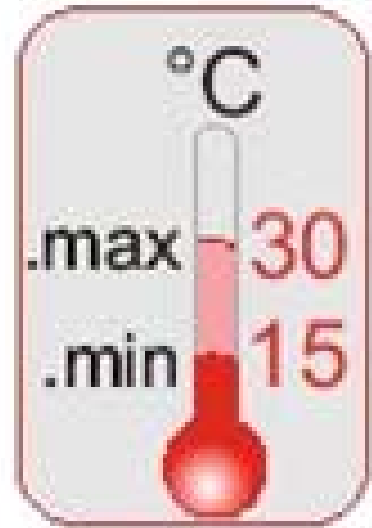

The Rapid Charger is available as an optional accessory, or as a standard item in a “Premium Kit” package.

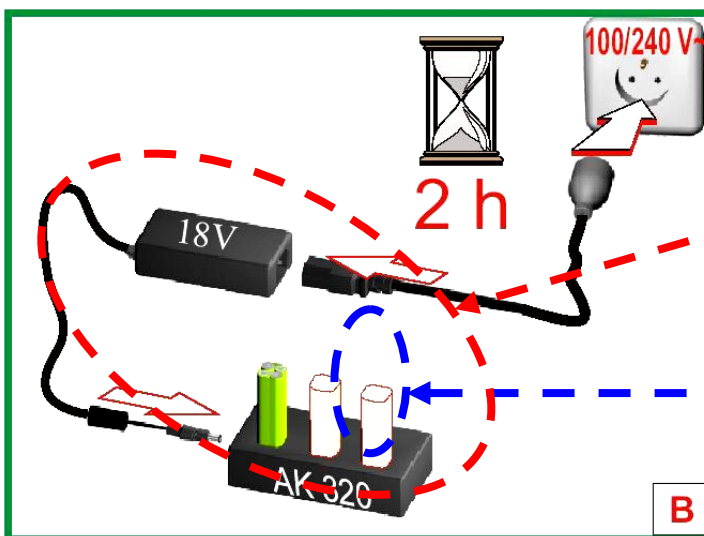

Rapid Charger – charged to 85% in 2hrs (Applicable to the standard 720mAh batteries). If larger batteries are offered in the future, charge time will extend in proportion. IE A 1000mAH would be around 3 hrs.

Spare Batteries can also be purchased

Step 3: Activating the RS320 Stick Reader and read test

Press the Green Button to “Wake Up” the reader from Sleep Mode.

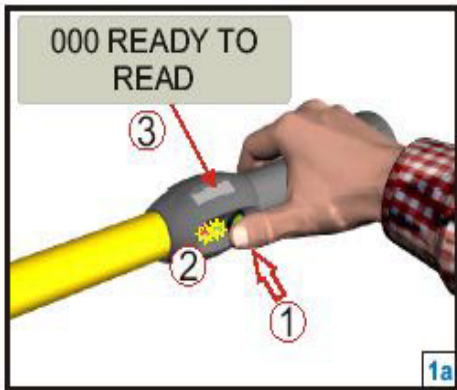

After the reader is awake – Press the button to read a tag.

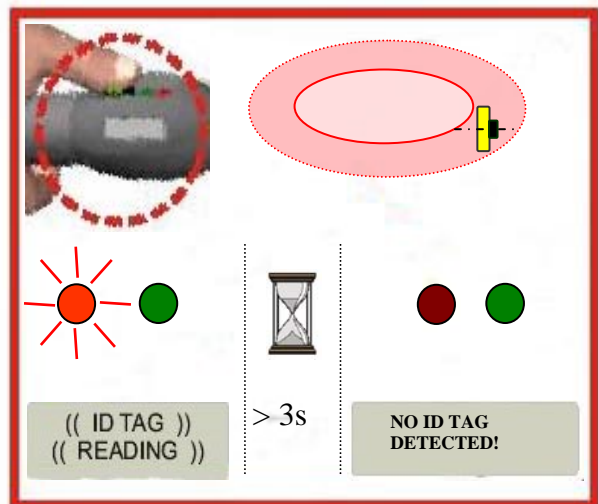
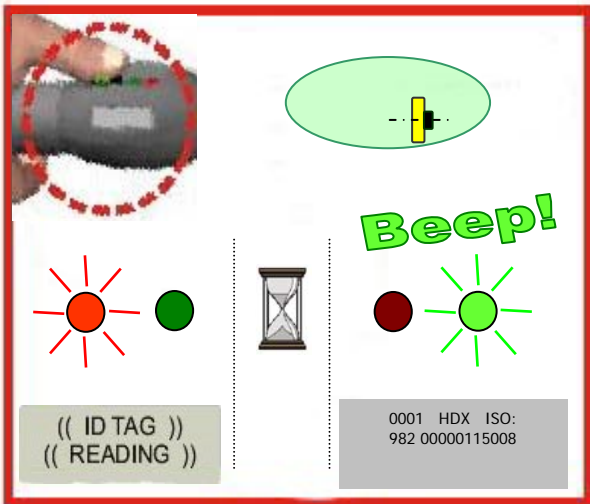
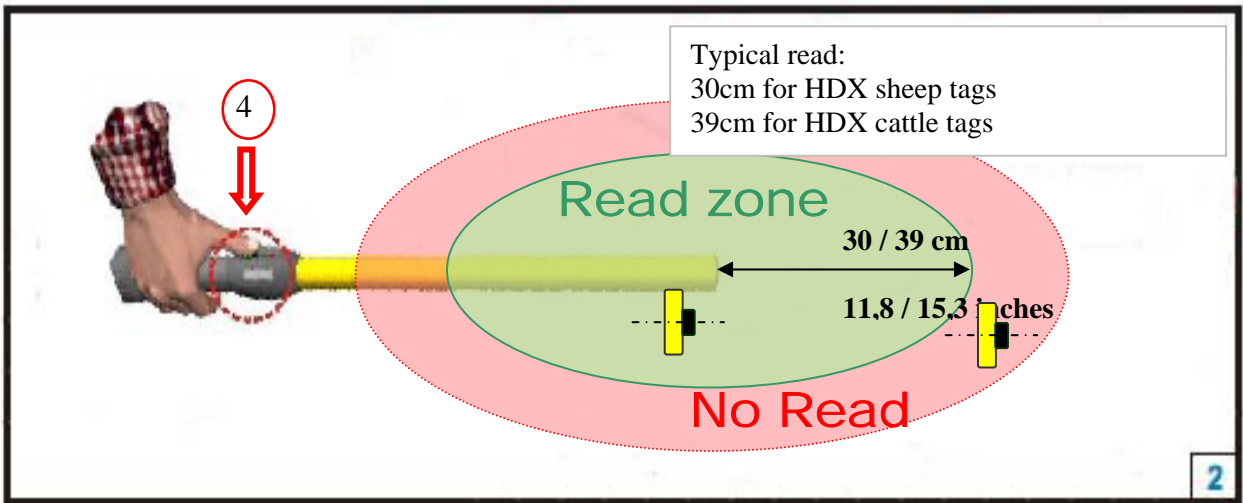

When the button is depressed, the red lamp will flash indicating that it is looking for a tag. Keep the green button depressed and when a tag is detected, the green light will flash and the reader will emit a beeping sound. The display will show the Tag number and the Count.

Stick Reader Power Supply

Power Source Requirements

The RS320 Stick Reader contains a 9.6VDC – 720mAh NiMH rechargeable battery pack, which serves as its primary power source. Alternately, the RS320 can be powered:

- From its external AC Adapter/Charger (Via the serial cable),
- Via the power supply cable with alligator clip* in conjunction with any external DC power source (Input Rating 9-12 VDC – 1A).
- By connecting to older model battery packs (PW250) that were used with the Grey (RS250) Allflex Stick Reader.

Special Notes Regarding Power Requirements

The older RS250 (Grey) stick readers can be powered by connecting directly to some weigh scale heads (without the battery pack). The RS320 (Yellow) requires a higher voltage level than most scales produce and hence cannot be used in the same manner, unless the scale head is externally powered from a car battery, or AC charger. Otherwise, the yellow reader must have its own charged battery inserted.



Note 1 - The RS320 Stick Reader is designed to operate only with the Battery Pack provided. The RS320 will not operate with individual battery cells of either disposable or rechargeable variety.

CAUTION
RISK OF EXPLOSION IF BATTERY IS REPLACED BY AN
INCORRECT TYPE.
DISPOSE OF USED BATTERIES ACCORDING
TO THE INSTRUCTIONS

* Not proposed for sale in Europe



Note 2 - Do not use this apparatus near water when connected to AC/DC adapter.



Note 3 - Do not install near any heat sources such as radiators, heat registers, stoves, or other apparatus (including amplifiers) that produce heat.



Note 4 - Unplug this apparatus during lightning storms or when unused for long periods of time.

AC Adapter - The RS320 Stick Reader can be powered using its AC Adapter/Charger regardless of the charge state of the Battery Pack. The AC Adapter can be used as a power source even if the Battery Pack has been removed from the Stick Reader. If the AC Adapter has been connected, the user may proceed with configuration and performance testing while the Battery Pack is charging. This configuration could affect reading performances.



Note 5 - The Stick Reader's integral Battery Pack is affected by temperature. At 0°C (32°F), the Battery Pack will deliver only about half of its rated energy capacity. At lower temperatures, the Battery Pack may deliver unsatisfactory performance. When the RS320 Stick Reader is used in low temperature environments, connection to an external power source, such as the Allflex PW250 Battery Pack, and placement of this external Battery Pack close to the user's body, is recommended.



Note 6 - To ensure proper Battery Pack charging, charging should be conducted only in an environment where the temperature is between 15°C and 30°C (60°F to 85°F). Charging at temperatures outside these boundaries will result in unsatisfactory charge acceptance by the Battery Pack. For more information about the characteristics of rechargeable batteries, please see the white paper at [\[http://www.national.com/appinfo/power/files/f19.pdf#page=1\]](http://www.national.com/appinfo/power/files/f19.pdf#page=1).

Power supply cable with alligator cable*

You can connect your stick reader to any 12V DC power supply such as a car, truck, tractor, or motorbike battery. The Stick Reader is connected through the socket located on the back of the Stick Readers data cable as shown in step 2.

The reader is protected for reverse polarity connections.



Step 1

Connect the black alligator clip to the negative terminal (-). Connect the red alligator clip to the positive terminal (+).



Step 2

Connect the other end of the battery cable into the power socket located at the end of the Stick Readers data cable



Step 3

You should now be ready to start using your stick reader. Press the READ button momentarily and observe the red lamp flashes, indicating that it is receiving power.

* Not proposed for sale in Europe

Activating the Stick Reader

With the Battery Pack fully charged and installed, or with the AC Adapter connected by means of the Data/Power Cable, the Stick Reader is ready to be used. To turn on the Stick Reader, press the green READ button, holding it down until the red and green indicators light and extinguish (this is about ¼ second duration).



Note 7 - Very brief presses of the READ button will cause the indicators to light, but will not be sufficiently long to latch the Stick Reader into its power on state. Be sure to hold the READ button down.

When the Stick Reader is powered up, the LCD readout appears as shown below:

0000	READY TO READ
-------------	--------------------------

This power-on message indicates that the Stick Reader's internal ID code memory has been cleared and that the Stick Reader is ready to read new tags. If the reader has been previously used and ID codes are stored in memory, the LCD readout will be as follows:

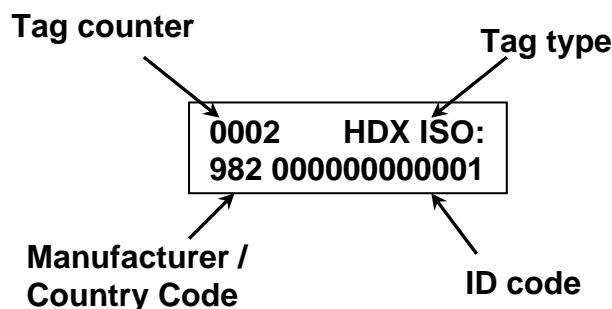

HDX ISO: indicates standard ISO Half Duplex cattle.
982 corresponds to Allflex manufacturer code.

Display formats for other tag formats (other than ISO HDX tags) that can be read by the RS320 Stick Reader are shown below for ISO FDX-B and industrial HDX coded tags.

0002 FDX-B ISO: 982 009101723121

0014 TIRIS:2048 0000000000053925



Note 8 - Each ID Code is stored internally in the Stick Reader's non-volatile memory until the user deliberately erases the stored ID codes after downloading them into a recording device, such as NLIS Link (Australia only) or a PC database. Up to 3200 ID codes can be stored and retrieved later at the user's convenience.



Note 9 - The "Tag Counter" feature on the LCD readout can be reset to zero at any time by double clicking the READ button, and observing the LCD's display "Reset Counter?". Depressing the READ button again for 5 seconds, while this message is displayed on the screen will force the Tag Counter to reset to the value "0000". Resetting the Tag Counter does not alter the ID codes previously read and stored in the Stick Reader's internal memory.



Note 10 - The Stick Reader provides a "New Animal Group" Function that inserts a line of all zeroes into the list of RFID numbers stored. This is used to separate mobs of stock in the memory. Each time you wish to insert a "New Animal Group" you simply access the option via the menu (2 quick button presses and trigger it by depressing the button for 5 seconds while the "New Animal Group" message is displayed. Inserting a "New Animal Group" will not reset counter. Reset counter manually if required.

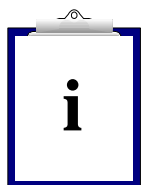

Note 11 - The Stick Reader will **scan for duplicate tag numbers** in a list containing the last 100 tags scanned. This number (100) can be altered to scan lesser values such as 25, 50, 75 or up to as many as all the tags in memory. This is done using Allflex Stick Reader Configurator© Software or by contacting Allflex Support. When a "New Animal Group" is initiated, duplicate search is also reset.

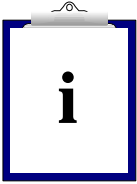

Note 12 - Once activated, the reader will remain activated for 30 seconds. This is the default value and can be configured from 1 second to 255 seconds, or to “Always On”. These changes are achieved using Allflex Configurator© software.

Reading eartags

When a tag is successfully read, the tag's ID code information appears on the LCD readout. For “non-duplicate” tag readings, the tag counter will be incremented and the ID code is automatically stored in the Stick Reader's internal memory.

Tag numbers that are read as duplicates are not stored in memory and the counter is not incremented. This means if you scan a tag twice within the Duplicate Search Limit of 100 scans, it will be stored originally but not the second time. If you scan the same tag twice outside the Duplicate Search Limit of 100 tags, the number will be stored twice and the counter will be incremented for both scans.

The Stick Reader's green LED indicator flashes and the buzzer will sound for every scan. A single flash/beep occurs the first time a tag is read and a double flash/beep indication occurs for duplicate tag reading.

Every time a tag is scanned, according the Stick Reader configuration (send repeats, do not send repeats or send upon re-read), the number can be transmitted or not out of the serial data cable / Bluetooth® ports if it is a duplicate.

Using the function menu

A menu is available on the Stick Reader that groups together 4 functions. These four functions are used:

- To reset the tag counter to zero.
- To create a New Animal Grouping (“New Animal Group” Field - a line of zeros – 000000000000).
- To reset the Stick Reader configuration (Factory Settings).
- To enable Bluetooth®.

To access the menu, double-click on the green READ button when the Stick Reader is awake. Press the READ button quickly to switch to the next menu function.

To execute a menu function, whilst the menu function you require is displayed (“New Animal Group” for example), press and hold down the READ button for 5 seconds. A countdown appears at the bottom right of the LCD readout and is accompanied by a beep. The function is only executed once the countdown has reached ‘0’ and a long beep is sounded. A confirmation message is then displayed on the readout.

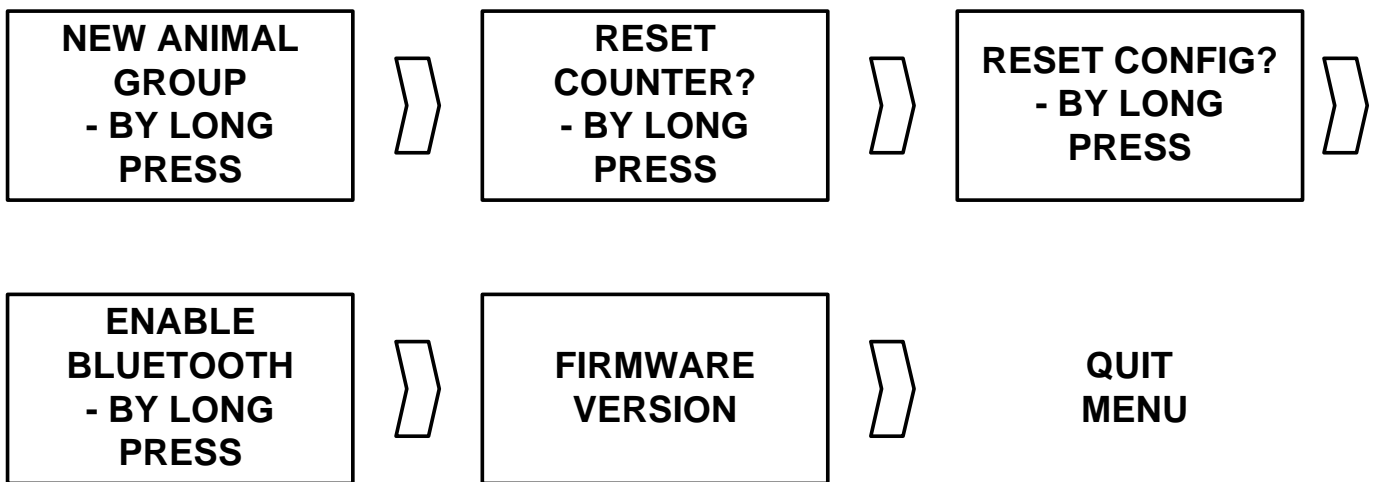

To quit the menu, press the READ button quickly when the last function is displayed on the readout, or simply wait a few seconds.



Note 13 - Function execution is cancelled if the READ button is released before the countdown reaches ‘0’.



Note 14 - The Stick Reader automatically closes the menu if no action occurs for 3s.



It is impossible to read a tag when the menu is activated.

Read Range Performance

Figure 2 illustrates the read zone of the Stick Reader, within which tags can be successfully detected and read. Optimum read distance occurs depending upon the orientation of the tag. Tags and implant read best when positioned as shown below.

Figure 2 - Optimum Read Distance Tag Orientation

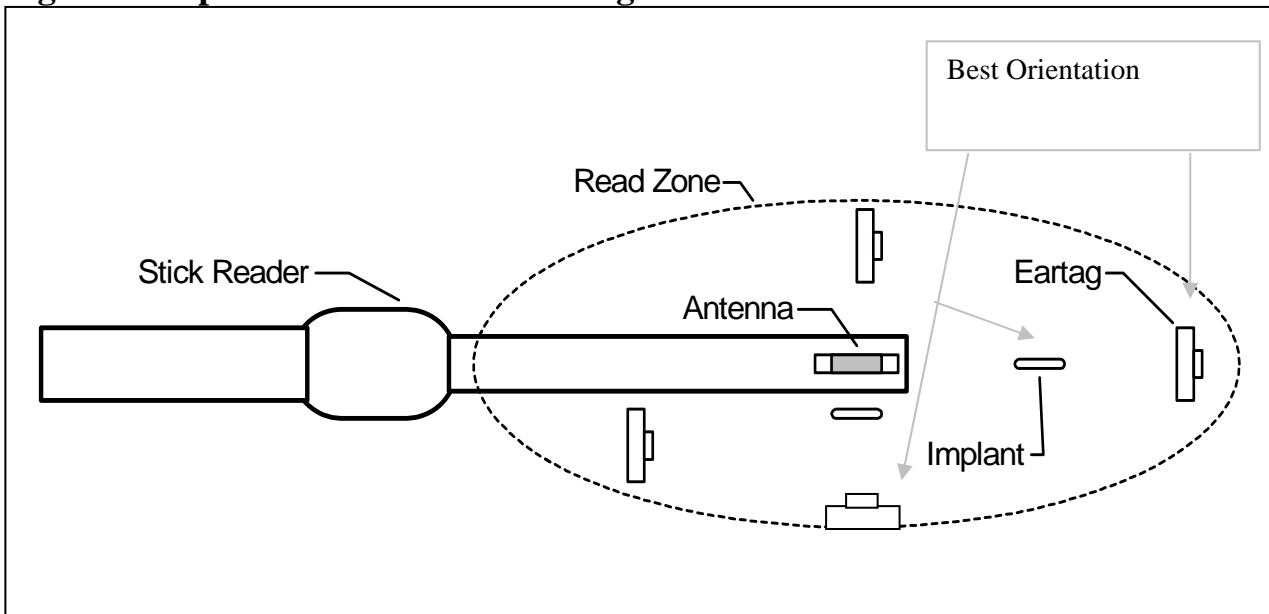

Table 2 lists typical read distances that can be expected when reading different types of Allflex eartags, in the optimum tag orientation at the end of the Stick Reader (as shown in Figure 2).

Table 2 - Typical Read Distances for Various Allflex Eartags

Tag Type	Using charged battery pack
HDX/HP Eartag (NLIS/Cattle Tag)	39 cm or 15.5 inches
FDX-B/HP Eartag	34 cm or 13.5 inches
HDX/LW Eartag (Sheep / Swine)	30 cm or 12 inches
FDX-B/LW Eartag (Sheep / Swine)	32 cm or 12.5 inches

Factors that affect read range performance

Tag reader efficiency is often linked with reading distance. The Stick Reader's read distance performance is affected by the following factors:

Transponder orientation - To obtain maximum reading distance, the axes of the transponder and reader antenna coils must be optimally orientated as shown in Figure 2.

Transponder quality - Each manufacturer's transponder differs by (a) the level of exciter signal energy required for the transponder internal circuits to operate sufficiently, (b) the signal level of the ID code information that is returned to the reader. Consequently, it is normal to find that common type transponders (for example, FDX-B) from different manufacturers have different read range performance levels.

Animal movement - If the animal moves too quickly, the reader may not be located in the read zone long enough for the ID code information to be obtained.

Transponder type - HDX transponders generally have larger reading distances than similar-sized FDX-B transponders.

Nearby metal objects - Metal objects located near a transponder or reader may attenuate and distort the magnetic fields generated in RFID systems and therefore, reduce reading distance. A good example being the eartag caught in a head bale significantly reduces the read distance.

Electrical noise interference - The operating principle of RFID transponders and readers is based on electromagnetic signals. Other electromagnetic phenomena, such as radiated electrical noise from other RFID tag readers, or computer screens may interfere with RFID signal transmission and reception and therefore, reduce reading distance.

Transponder/reader interference - Several transponders in the reception range of the reader, or other readers that emit excitation energy close by may adversely affect reader performance or prevent the Stick Reader from operating.

Discharged battery pack - As the battery pack discharges, the power available to activate the field becomes weaker and this reduced field results in a reduced reading range.

ID Code Memory

The Stick Reader has an internal non-volatile memory that can store 3200 ID codes. Non-volatile memory means that the data in memory will not be lost even if the battery goes flat. Non-volatile memory is only cleared by sending a specific command to the reader. This is done from software like NLIS Link (Australia only) or HyperTerminal® etc.

ID codes are stored automatically when they are read. A transponder ID code will not be stored several times if the same tag is read successively several times, but if the reader is configured by the user to have the “Duplicate Search” function set to “Last Tag”, It will be stored several times in memory if other tags are read in between. When more than 3200 ID codes are read, the new ID codes overwrite the oldest ID codes in memory.

Using the Stick Reader's Serial Data Interface

The RS232 serial data interface is available on the RS320 by connecting the detachable Data/Power Cable to the Cable Connector located on the Endcap. The Stick Reader's Cable Connector is covered with a protective cap to guard against foreign material contamination. Remove this cap and install the Data/Power Cable by engaging the connector and rotating the lock-ring.

The RS232 serial interface comprises a 3-wire arrangement with a DB9F connector, and consists of transmit (TxD/pin 2), receive (RxD/pin 3), and ground (GND/pin 5). Figure 3 illustrates the power and data wiring of the Power Jack and Data Connector. This interface is factory configured with the default settings of 9600 bits/second, no parity, 8 bits/word, and 1 stop bit (“**9600N81**”). These parameters can be changed by using the options included in the Configurator© program.



Note 15 - The RS320 Stick Reader is provided with the connectorized endcap and detachable Data/Power cable in its standard configuration.



Note 16 - The Stick Reader RS232 interface is wired as a DCE (data communications equipment) type that connects directly to the serial port of a PC or any other device that is designated as a DTE (data terminal equipment) type. When the Stick Reader is connected to other equipment that is wired as DCE also (such as a Palm Pilot or Pocket PC), a “**null modem**” adapter is required in order to properly cross-wire transmit and receive signals so that communications can occur.



Note 17 - The Stick Reader's serial data connection can be extended using a standard DB9M to DB9F extension cable. Extensions longer than 20 meters (~65 feet) are not recommended for data, and extensions longer than 2 meters (~6 feet) are not recommended for data and power.

Figure 3 - Stick Reader Power Jack and Data Connector Wiring Diagram

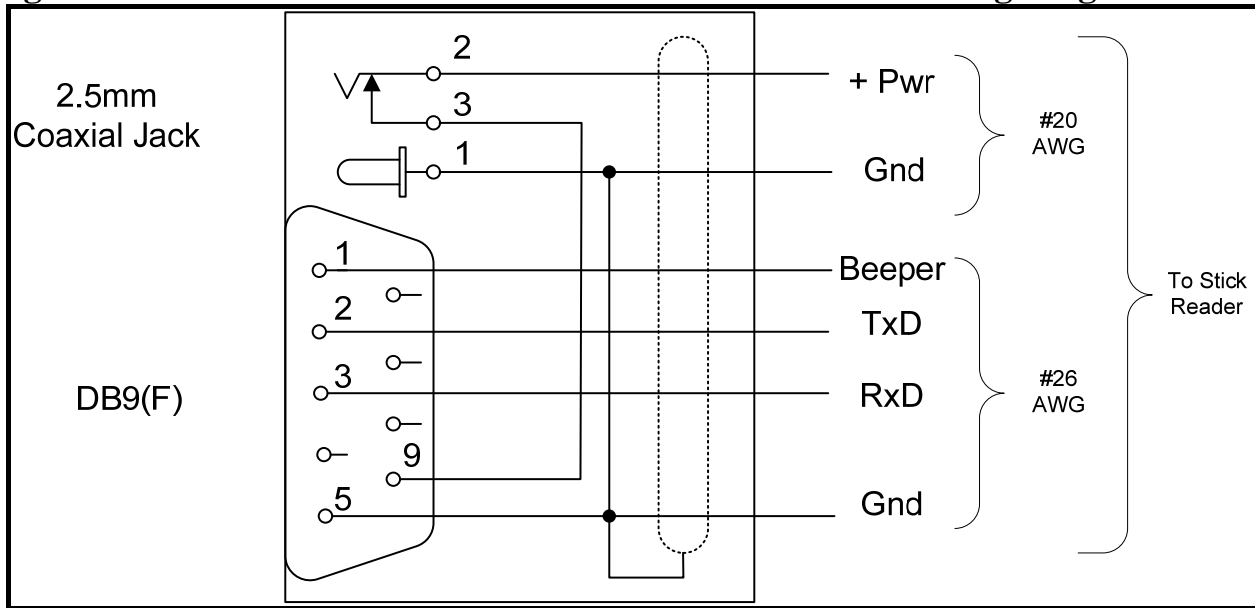

Serial output data appears on the Stick Reader’s TxD/pin 2 connection in ASCII format, which is compatible with most PC terminal emulator programs, such as HyperTerminal®.

Table 3- Default Serial Data ID Code Formats

Tag Type	Default Format
HDX ISO	LA_982_000001088420{CR}{LF}
HDX Industrial	LR_0006_0000000018514243{CR}{LF}
FDX-B ISO	LA_982_000000255895{CR}{LF}

Note: _ = space; {CR} = carriage return; {LF} = line feed

Interpreting Tag ID Code Information

Table 3 lists the default data formats that are transmitted from the Stick Reader’s serial communications port, in response to reading compatible type tags. For ISO type tags, there is no contextual differentiation between HDX and FDX-B outputs. Both types of tags produce a default format:

LA_982_000001088420{CR}{LF}

Where the underscore “_” represents a space character, and {CR}{LF} is a carriage return /line feed (unprinted / invisible control characters which cause a PC’s display cursor to jump to the beginning of the next line prior to displaying the next ID number).

In the above data output, the prefix “LA” represents “line mode – animal coded read only tag”, “982” is the Allflex manufacturer number assigned by an international organization called ICAR. The last 12 digits comprise a unique number sequence for the particular tag being read.

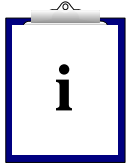

Note 18 - The manufacturer code “982” will be different for another manufacturer’s tag. Also some countries use transponders that use Country Coding instead, for example, Canada. In these cases the Country Code is displayed and not the manufacturer’s code.



Note 19 - While HDX and FDX-B type transponders have an identical format, they are guaranteed by Allflex to be unique. That is, HDX tag type ID numbers are never duplicated in FDX-B type tags, despite their sharing the same manufacturer ID code (“982”).

For HDX Industrial coded tags, the output format is:

LR_0006_0000000018514348{CR}{LF}

In this tag format, the prefix “LR” represents “line mode – industrial coded read only tag”, “0006” is an application code unique to Allflex, and the last 16 digits comprise a unique identifying number sequence. Industrial tags are not used in regulatory animal identification schemes, such as the NLIS in Australia, NAIT in NZ, etc. This information is supplied only for users of tags with non animal applications, such as asset tracking, etc...

The above default formats can be changed using the Allflex Configurator© software which is on the CDROM or the Stick Reader Configuration Program which is obtained by contacting Allflex (Australia only).

Using Bluetooth®

The CM301 is an endcap for the reader that contains a Bluetooth® module. The CM301 Bluetooth® module (see page 36) allows the RS320 to send and receive data “wirelessly” via a Bluetooth® connection.

To make Bluetooth® operate you need to connect the Bluetooth® reader with another Bluetooth® enabled device, like a PDA (hand held computer), computer, or a Bluetooth® dongle that is attached to a scale head (as shown below).

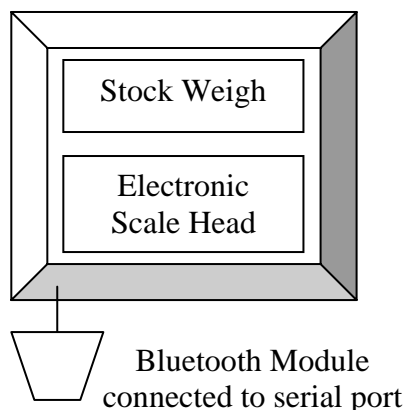

If you are using a PDA or computer you will require software. (Not supplied by Allflex)

Your software supplier will explain how to connect the PDA, or your computer to the Allflex Reader.

Bluetooth® works on a premise that one end of the communications will be a MASTER and the other a SLAVE. The MASTER initiates communications and looks for a SLAVE device it has been connected to. PDAs and

computers usually behave as MASTERS.

WARNING: When used in the appropriate manner and setup correctly, Bluetooth® offers an excellent method of cable free data transfer. However, Bluetooth® can also be made far too complex by some users.

Allflex advises that to achieve successful implementation of Bluetooth® with our RS320 reader, users are specifically requested to follow the simple implementation methods listed (following).

If these implementation methods are not followed, Allflex cannot guarantee that implementation will not be problematic. This means the Bluetooth® connection may become inconsistent, thus causing other reader related errors.

Bluetooth® – Known Successful Methods

There are 5 scenarios to correctly implement Bluetooth®. These are:

1. RS320+CM301 to a Bluetooth® adapter connected to a scale head.
2. RS320+CM301 to a Bluetooth® adapter connected to a Computer Serial Port.
3. RS320+CM301 to a Bluetooth® enabled computer.
4. RS320+CM301 (With Hardware ON/OFF switch*) to a Bluetooth® enabled PDA (Palm Top Computer/Portable Data Assistant)
5. RS320+ CM301 to a dedicated Bluetooth® device, such as printer.

These options are discussed in further detail below.

1. RS320+CM301 to a Bluetooth® adapter connected to a scale head.

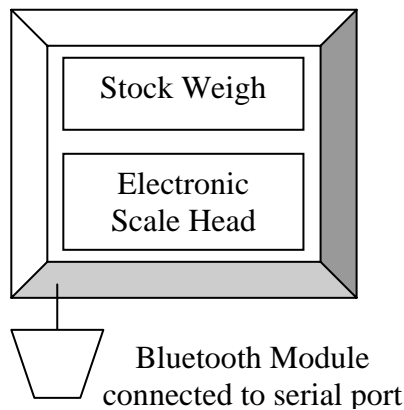

This scenario requires that a process called “Pairing” be undertaken. This requires the Allflex Configurator© software to configure the reader to correctly link to the Bluetooth® module connected to the scale head. Most Allflex offices pre-match readers to Bluetooth® adapters prior to dispatch.

If your RS320 and Bluetooth® adapter have not been set up for you, or have lost their pairing, Allflex Configurator© Software will be required to complete the Pairing Process.

Depending upon the country, Allflex Configurator© Software will either be supplied on a specific Configurator© CD supplied with the reader, or included on other CD’s such as NLIS Link in Australia. Install the Configurator© Software. The scale head serial port must supply power on pin 9.

* Please contact your Allflex reseller for this specific Bluetooth module

Connect the wand to the PC via the serial cable and computer serial port.

Start the Configurator© software and turn on the reader. The reader's current settings will appear on the screen. If they don't, click on "Get Settings".

- The Configurator© has several TABS across the top section.
- Select the "**Wireless Technologies**" screen by clicking on the "Wireless Technologies" Tab.
- The Stick Reader settings must be set to the following:
 - **Power Module:** ON
 - **Connection Mode:** MASTER
 - **Device Pairing:** ON
 - **Pairing Slave ID;** use the address code found on the small label on the Bluetooth® Adapter that attaches to the scale head. The code will usually look something like this: **00BCE0076A3**

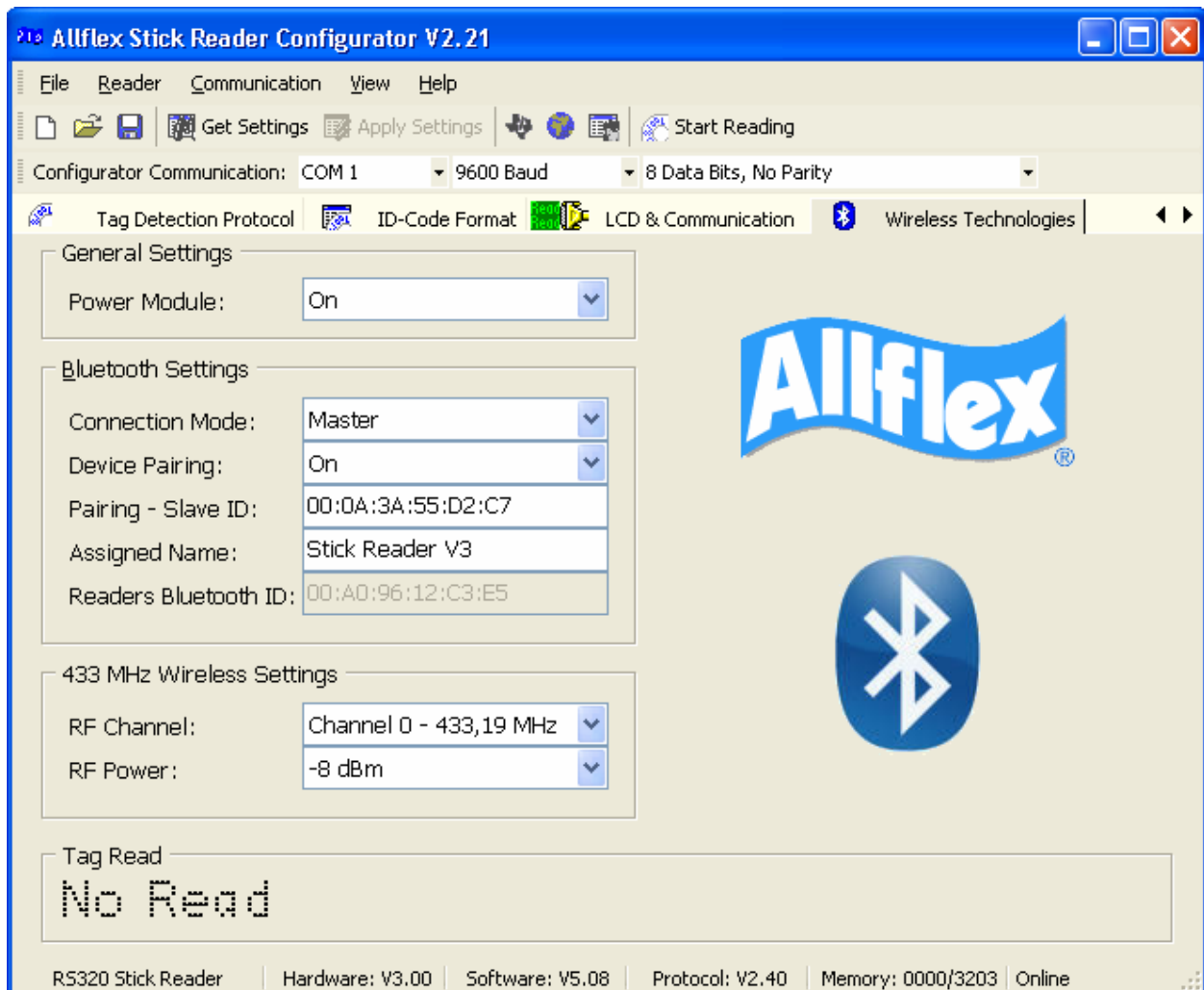

- Select the “Operational” Tab (if it is hidden on your screen, click on the left arrow button which is to the right of the word “Wireless” on the “Wireless Technologies” Tab.

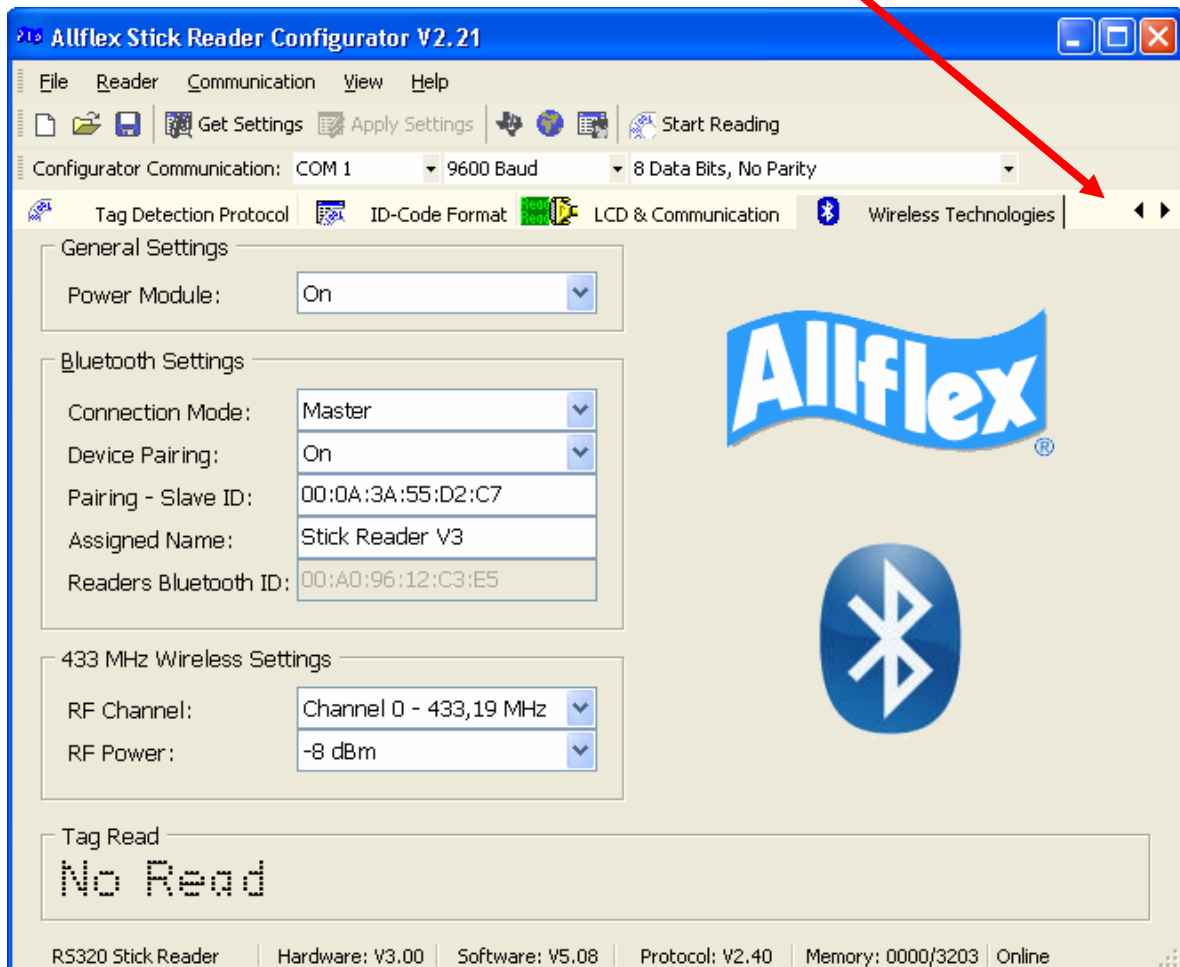

- Change the **TIME ON** setting to be ALWAYS ON.
- Click on **APPLY SETTINGS** button. (Make sure the button turns grey – keep clicking until it does turn grey)
- Detach the curly serial cable and unscrew the serial end cap off the reader.
- Attach the Bluetooth® End Cap and turn the reader on.
- You will see a message that the Reader is Configuring the Bluetooth®.
- If the message is very brief – power down and restart the reader.
- Make sure the Bluetooth® adapter is attached to the correct port of your scale head (CON2 on a Tru-Test XR) Also ensure the XR is powered up.
- **Note:** If the Bluetooth® Receiver adapter is not plugged into CON2 on an XR it will not work as this is where it receives power.

- A Bluetooth® symbol will appear next to the counter on the top left hand-side of the stick reader display indicating it is connected. Data should now transfer from the wand to the scale head when you scan a tag.



Note 20 - the Bluetooth® settings are saved in the WAND not the Bluetooth® endcap. For example, if you configure a wand to talk to a specific Bluetooth® receiver adapter, you can swap the Bluetooth® endcap on the reader and the system will continue to work as expected. If you swap the wand however, the connection will not work, unless you program the new wand to connect to the Bluetooth® adapter attached to the scale head.

The settings are stored in the reader memory. The settings are NOT applied to the CM301 Bluetooth® module until the module is fitted to the reader and it is powered up. At this point the screen will say “Configuring Bluetooth® Module”



Note 21 - Because you have set the TIME ON setting to ALWAYS ON, the only way to power the reader down is to unscrew the endcap and allow the battery to momentarily detach.

2. RS320+CM301 to a Bluetooth® adapter connected to a Computer Serial Port (Not for sale).



Under this scenario, a Bluetooth® adapter is used in the same manner as in the previous scenario, however, as you will see the Bluetooth® Adapter cable is different. This cable allows the adapter to be connected to the serial port of a computer (using the DB9 connector) and also to receive power from the computer (using the USB cable).

The reader Bluetooth® configuration is exactly the same as the previous scenario.

The software on the computer should be set to connect to the reader, via the serial port as if there was a cable in place. This scenario also allows computers to be used that are not Bluetooth® enabled.

3. RS320+CM301 to a Bluetooth® enabled computer.

The reader should be a SLAVE, PAIRING OFF, TIME ON = ALWAYS ON (Configured using the Allflex Stick Reader Configurator© program).

Tips

Sometimes, a PIN code is required to connect the “Stick Reader RS320 – RF Bluetooth®” to the PC, PDA... In such case, the PIN code to use is (case sensitive):

default

4. RS320+CM301 (With Hardware ON / OFF switch) to a Bluetooth® enabled PDA (Palm Top Computer / Portable Data Assistant)

To Be Advised.

5. RS320+CM301 to a dedicated Bluetooth® device such as printer.

Under this scenario, the Allflex Configurator© software is used to set the **Power Module: ON**

Connection Mode: MASTER

Device Pairing: ON

Pairing Slave ID: Use the ID HEX Code for the Bluetooth® module of the printer. Sometimes this is not written on the device. One way to find the address for the Bluetooth® printer is to use a computer or PDA with Bluetooth® and discover the printer and then view the Details. Once you know the address, enter it into the “Pairing Slave ID” field. All the settings above are in the “Wireless Technologies” Tab.

It is recommended that the **TIME ON** setting in the “Operational” Tab also be set to ALWAYS ON.

It may also be necessary to adjust the data string being sent to some printers to get the correct data onto the label. In the case of the Zebra QL320 printer shown, we set the **COMMAND PROMPT** (in the “ID-Code Format” Tab) to: NO PROMPT (default value).



NOTES:

Optional accessories for the RS320 Stick Reader

CM301 Bluetooth® Module

The Bluetooth® module provides wireless communication between the RS320 and a Bluetooth®-compatible device. The maximum range of this wireless link could reach 100 m depending on the environment, if allowed by the matching Bluetooth® compatible device.

This device contains FCC-ID POOWML-C30XX and is approved in accordance to R&TTE directive transmitter module marked by CE product label, manufactured by MITSUMI incorporated to OEM module.

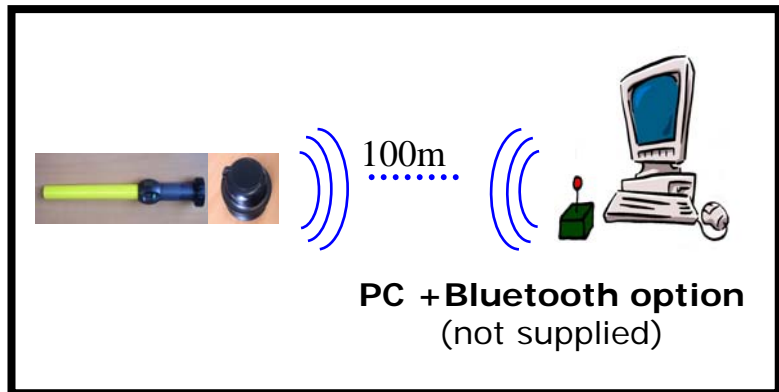

PW320 Battery Pack

The PW320 Battery Pack is used to supply power to all versions of the RS320 Stick Reader.



AK320 Battery pack fast charger

The AK320 fast charger is used to charge up to 3 PW320 Battery Packs simultaneously in 2 hours. A flashing light indicates rapid charging mode. A flashing light indicates charge is less than 85% and not in trickle charge / fully charged condition.



Battery orientation!

PW250 Battery Pack

The PW250 Battery Packs are portable power sources typically used for the older version RS250 (Grey) Allflex Stick Reader. These batteries can also be used to power the RS320 Stick Reader. The PW250 provides power for approximately 4000 read cycles. It can be fully recharged in 10h and only requires 2.5h to be recharged to 80% capacity.

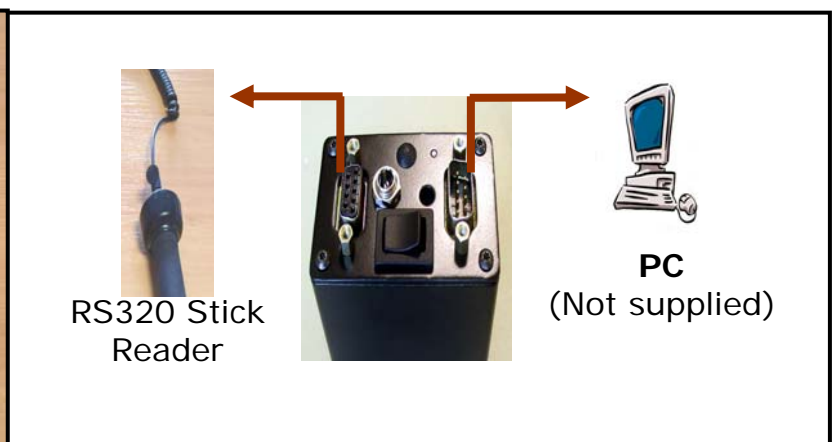

Removable curly serial cables

Spare serial cables exist in 3m lengths.



Stick Reader



PC
(not supplied)

Plastic Carry Case

Durable Plastic Carry Case is available as an optional extra or is included in the “Premium Kit” Package.



Serial Command Language

This section is designed for the use of programmers and advanced users.

The instructions listed in Table 4, describe some of the basic and more frequently used configuration options. It illustrates how to implement them using the Stick Reader Serial Command Language in conjunction with HyperTerminal®. The Command Language method uses upper and lower case alpha characters combined with hexadecimal characters to establish the Reader's configuration.

Table 4 - Frequently used command language characters

Command	Application
P	The reader's current settings are sent in command language format
Bnnnnnn	Configures the ID code serial data format
Snn	Sets serial data communication parameters
Inn	Sets the miscellaneous options
r	Resends the last tag read
R	Initiates reading (the Stick Reader must already be powered up)
G	Retrieves all the ID codes stored in memory
Mnn	Sets ID code memory options
C{Enter}	Clears the ID code memory
? or H	Retrieves the list of valid command language characters



Note 22 - For commands followed by “n” (hexadecimal characters), the user must press the {Enter} key on the PC after entering all the command characters. {Enter} does not need to be pressed for single letter commands, except as indicated in Table 1. For more details about the parameter “n”, the user should contact Allflex.

Connecting and Testing the Stick Reader Using HyperTerminal®

Step 1 - Connect the serial cable to the computers COM port (COM1 is the most common port used).

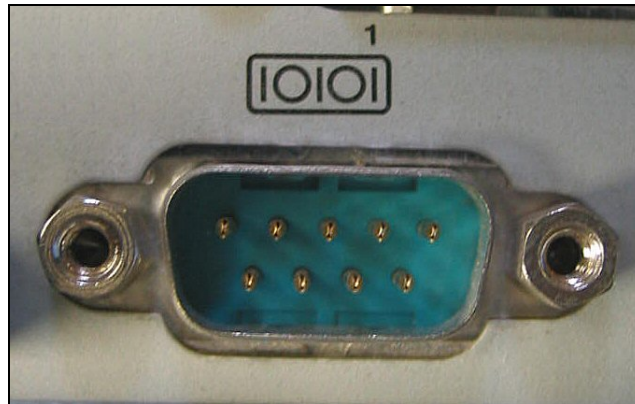

Step 1 – Connecting to COM port 1

Step 2 - Launch HyperTerminal® by going to the START button, then to Programs then to accessories then to Communications and finally click on the HyperTerminal® icon to launch the program.

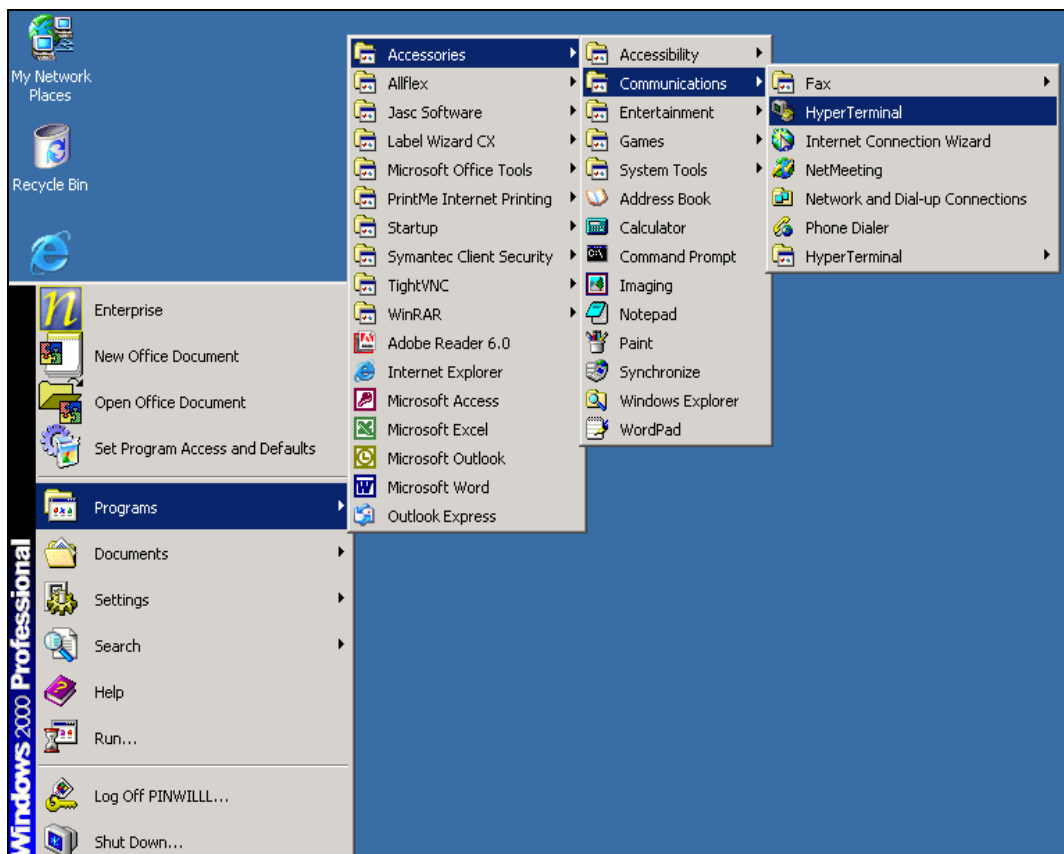

Step 2 - Selecting The HyperTerminal® Program

HyperTerminal® comes standard with most windows installation. It can also be downloaded free from

<http://www.hilgraeve.com/hpe/index.html>

When HyperTerminal® has fully loaded you will be asked to input a name for your new connection. We'll call this connection "Test".

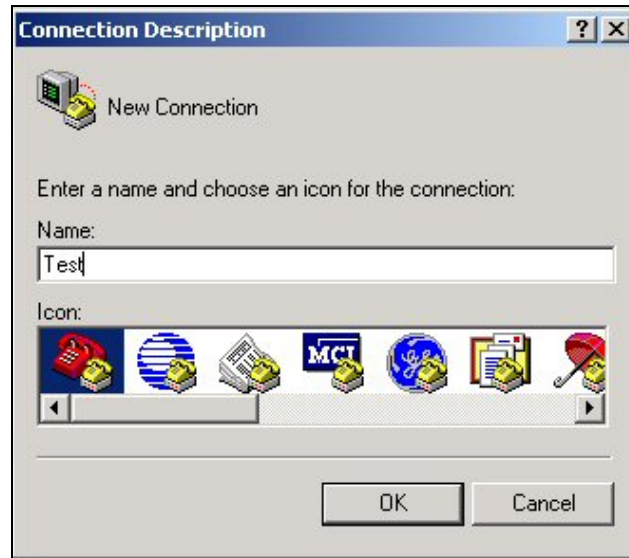

Step 3 - Starting a new connection

Step 4 - Next, select the COM Port that your Stick Reader is connected to. On most computers this will be COM 1.



Step 4 – Selecting the right connection

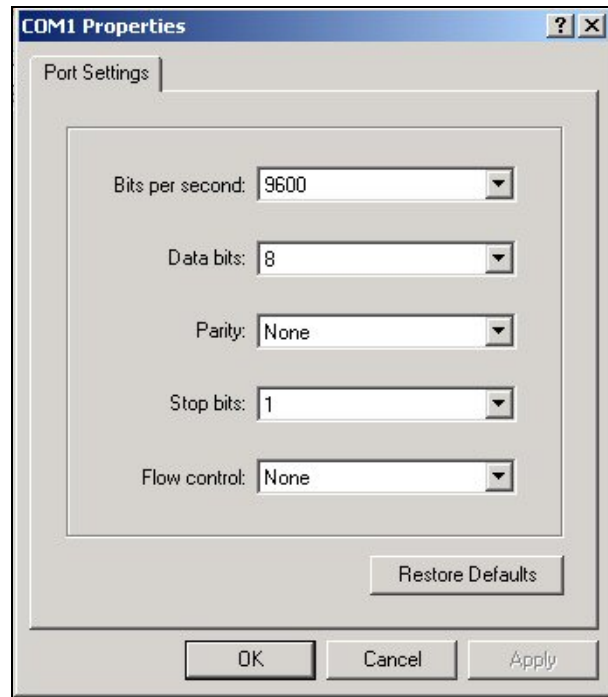

Step 5 - Setting up your connection properties

Step 5 - Click on the RESTORE DEFAULTS button to set the Baud Rate etc to 9600, 8, None, 1, None

Notice the caption and time label down the bottom left hand corner of the screen showing the status of the connection.

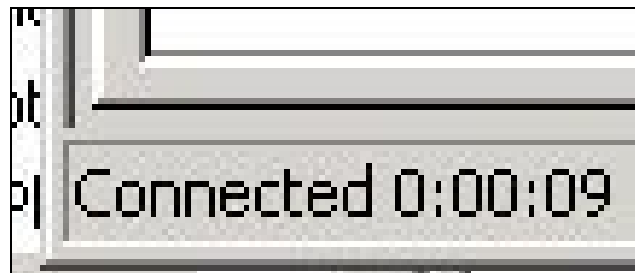

If you wish to disconnect or re-connect at any time you can use the two buttons in the top left corner of your HyperTerminal® Window.



Step 6 - Next, be sure that your Stick Reader is turned on and press the READ button. Bring a tag into the read zone. Observe the green light briefly flash, indicating a successful read. The HyperTerminal® window, should now display the ID code for the tag just scanned.

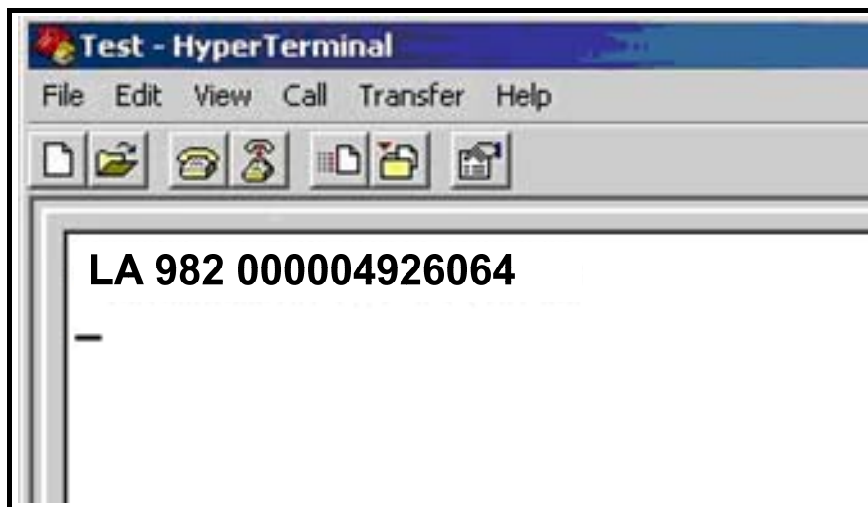

Even if the user intends to use a program other than HyperTerminal®, completing the steps above ensure that (a) the Stick Reader's operation and communication is verified and (b) the user becomes familiar with the basic operation of both the Stick Reader and HyperTerminal® as a backup application to other specific data transfer such as NLIS Link (Australia only).

Stick Reader physical integrity

The Stick Reader has been built from rugged and durable materials to withstand use in harsh environments for long periods of time. However, the Stick Reader contains electronic components that can be damaged if they are deliberately exposed to extreme abuse. This damage can adversely affect, or stop the Reader's operation. The user must avoid deliberately striking other surfaces and objects with the Stick Reader. Damage that results from such handling is not covered by the warranty described below.

Limited Product Warranty

Allflex guarantees this product against all defects due to faulty materials or workmanship for a period of one year following the date of purchase. The warranty does not apply to any damage resulting from an accident, misuse, modification or an application other than that described in this manual and for which the device was designed.

If the product develops a malfunction during the warranty period, Allflex will repair or replace it free of charge. The cost of shipment is at the customer's expense, whereas return shipment is paid by Allflex.

Refer all servicing to qualified service personnel. Servicing is required when the apparatus has been damaged in any way, such as power-supply cord or plug is damaged, liquid has been spilled or objects have fallen into the apparatus, the apparatus has been exposed to rain or moisture, does not operate normally, or has been dropped.



SPECIFICATIONS

EID_TS070002 Rev 1.1

Operating frequency	134.2 kHz
Standards	ISO 11784, ISO 11785
Tag compatibility	HDX, FDX-B
Reading distance^[*] <i>Using charged battery pack (w/o AC adapter)</i>	Allflex HDX HP Ø 30mm: 39cm Allflex FDX-B HP Ø 31mm: 34cm Allflex HDX LW Ø 26.4mm: 30cm Allflex FDX-B LW Ø 26.4mm: 32cm
Memory	3200 ID tags in a non volatile memory
User interface	2 x 16 characters backlit readout Red LED “Exciter active” Audible beeper and green LED “Good Read” One “Press to Read” push button
Comm. Interfaces	RS232 Serial Data Port (9600/N/8/1) – 1m coiled cable Bluetooth® (optional)
Comm. data format	Decimal or hexadecimal in ASCII format
Features	Retagging counter and user code management Software upgradeable via RS232 Serial Port

Battery pack	Internal removable rechargeable 9.6V NiMH battery pack
Power supply	Input: 100-240VAC – 50/60Hz Output: 12VDC – 1.5A

Temperature range	-10°C to +55°C
Material	Yellow fiberglass tube enclosure and black ABS plastic
Dimensions	L x D: 600 x 32mm or 450 x 32mm
Weight	60cm model: 660g (23 ounces) 45cm model: 570g (20 ounces)

Certifications	  Ref: SE-49151  Part 15.209, Subpart C (FCC ID: NQY – 930041)
-----------------------	---

These specifications may vary depending on the technical improvements

ISO 11784 & 11785

* Measured in a clean environment (no metallic object at less than 2 meters, devices generating radiated emissions are kept away from the reader). EID tags are placed in best orientation and have a resonance frequency at 134.2 kHz.

This device complies with the standards set forward by the International Standardization Organization. Specifically with standards
11784: Radio frequency identification of animals -- Code Structure
11785: Radio frequency identification of animals -- Technical Concept.

FCC ID: NQY-930041

This device complies with Part 15 of the FCC Rules. Operation is subject to the following two conditions: (1) this device may not cause harmful interference, and (2) this device must accept any interference received, including interference that may cause undesired operation.

Trademark Notices

HyperTerminal® is a registered trademark of Hilgraeve, Inc.
MS-Windows® is a registered trademark of Microsoft, Inc.
Configurator© is a registered trademark of Allflex USA, Inc.
Bluetooth® is a registered trademark of Bluetooth SIG, Inc.



DECLARATION OF CONFORMITY

According to the
R&TTE Directive 99/05/EC



Manufacturer's Authorized Representative: **ALLFLEX EUROPE S.A.S.**
Route de Eaux
ZI de Plagué
B.P. 90219
35502 VITRE Cedex, FRANCE
+33 (0)2 99 75 77 00

Type of Equipment: **Short Range Device (SRD) - Low Frequency
Radio Frequency Identification (RFID) Scanner**

Brand Name / Trademark: **Allflex**

Type Designation / Model No.: **RS320-3-XX (XX can be 45 or 60)
CM301 (optional)**

Allflex Europe declares on its sole responsibility that the products listed above are in conformity with the essential requirements of the R&TTE Directive.

The products comply with the following harmonized European Standards or technical specifications:

Standards	Regarding
EN 301 489-3 V1.4.1 (2002-08)	EMC
EN 301 489-17 V1.2.1 (2002-08)	EMC
EN 300 330-2 V1.3.1 (2006-04)	Radio Spectrum
EN 300 328 V1.6.1 (2004-11)	Radio Spectrum
EN 60 950-1 (2001)	Safety
EN 50 364 (2001)	Health

Allflex Europe has an internal production control system that ensures compliance between the manufactured products and the technical documentation.

March 6th, 2007

By:



Dominique BOIRON
Allflex Europe - RFID Director

Allflex Offices

<p>Allflex Europe (UK) Ltd. Unit 6 - 8 Galalaw Business Park HAWICK United Kingdom TD9 8PZ Phone: 44 (0) 1450 364120 Fax: 44 (0) 1450 364121 www.allflex.co.uk</p>	<p>Allflex Europe S. A. ZI DE Plague Route des Eaux 35502 Vitre, France Téléphone/Phone: 33 (0)2 99 75 77 00. Télécopieur/Fax: 33 (0)2 99 75 77 64 www.allflex-europe.com</p>
<p>Allflex USA, Inc. P.O. Box 612266 2805 East 14th Street Dallas Ft. Worth Airport, Texas 75261-2266 United States of America (800) 989-TAGS [8247] (972) 456-3686 (972) 456-3882/FAX www.allflexusa.com</p>	<p>Allflex S.A. Boulder 2820 Wilderness Place, Suite A Boulder, Colorado 80301 United States of America Phone: (303) 449-4509 Fax: (303) 449-4529 www.allflex-boulder.com</p>
<p>Allflex International Do Brasil Ltda. Rua Monte serrat, 1097 CEP 03312-001 Tatuape, SP, Brazil Phone/Fax: (55) 11 6942-7008 www.allflex.com.br</p>	<p>Allflex Argentina S.A. Las Heras 1588 1641 Martinez Buenos Aires, Argentina Phone/Fax: 54 11 4792 3488</p>
<p>Allflex Beijing Plastics No. 3 Heng Qu Tiao Dong Tie Jiang Ying Feng Tai District Beijing, China 100078 Phone: 861 762 9541 Fax: 861 762 9514</p>	<p>Allflex Australia 33-35 Neumann Road Capalaba Queensland 4157 Australia Phone: 61 7 3245 9100 Fax: 61 7 3245 9110 www.allflex.com.au</p>
<p>Allflex New Zealand Private Bag 11003 17 El Prado Drive Palmerston North Phone: 64 6 3567199 Fax: 64 6 3553421 www.allflex.co.nz</p>	<p>Allflex Canada Corporation Allflex Inc. 4135, Bérard St-Hyacinthe, Québec J2S 8Z8 Canada Téléphone/Phone: (450) 261-8008 Télécopieur/Fax: (450) 261-8028</p>